

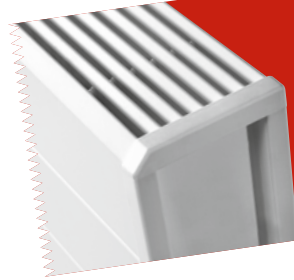

jaga



TEMPO WALL MOUNTED

Dimensions & heat output

AUDI MEMBER EN 442

LOW H₂O

30 YEAR GUARANTEE FIN FINE ELEMENT

DIMENSIONS

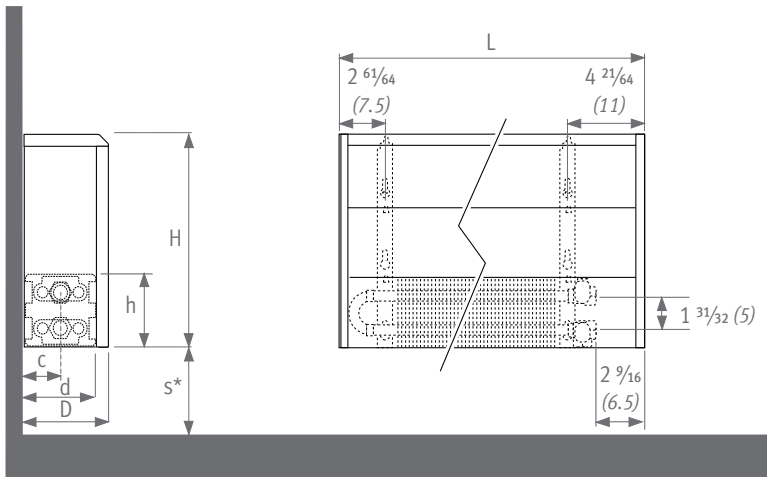

* Smaller dimensions can decrease output.

Type	d	h	D	c	s
10	3 15/16 (10)	3 15/16 (10)	4 41/64 (11.8)	2 3/32 (5.3)	3 15/16 (10)
15	5 29/32 (15)	3 15/16 (10)	6 39/64 (16.8)	3 5/64 (7.8)	4 23/32 (12)
20	7 7/8 (20)	3 15/16 (10)	8 37/64 (21.8)	4 1/16 (10.3)	5 29/32 (15)

Type	d	h	D	c	s
11	3 15/16 (10)	7 7/8 (20)	4 41/64 (11.8)	2 3/32 (5.3)	3 15/16 (10)
16	5 29/32 (15)	7 7/8 (20)	6 39/64 (16.8)	3 5/64 (7.8)	4 23/32 (12)
21	7 7/8 (20)	7 7/8 (20)	8 37/64 (21.8)	4 1/16 (10.3)	5 29/32 (15)

Type 10

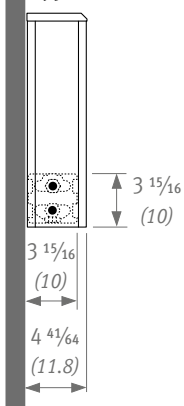

Type 11

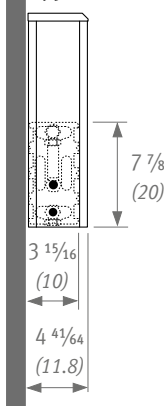

Type 15

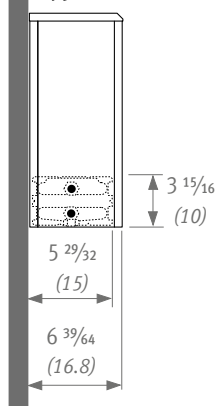

Type 16

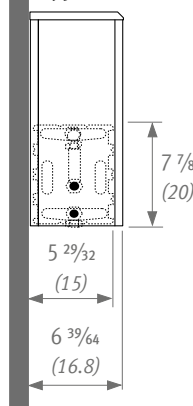

Type 20

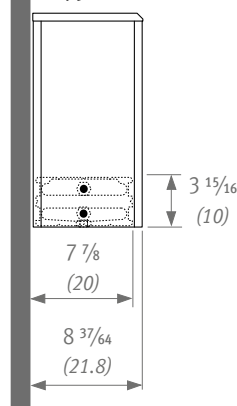

Type 21

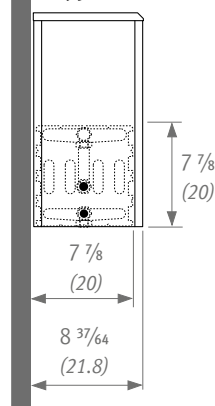

Note: dimensions in “()” are shown in centimeters.

The information in this technical brochure is correct at the time of printing. Jaga reserves the right to change product specification at any time in line with our policy of continuous improvement and innovation.

